

8

Protective elements



SEK
Page: 2



SEO
Page: 3



SES
Page: 4



FST
Page: 5



HUS
Page: 6



ST
Page: 7



SKS
Page: 10

Edge protection caps

SEK



Application protective elements
Material polyethylene

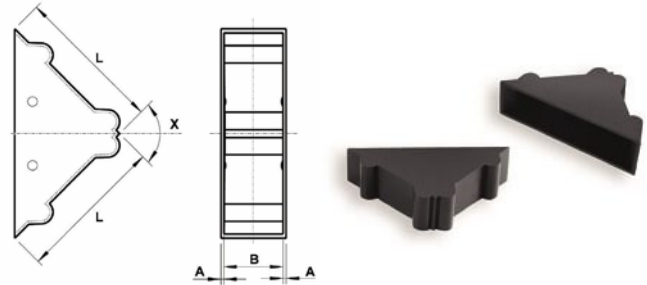

Order No.	Wall thickness	Plate thickness	Edge length	Angle	Color	packing unit	MOQ
	A	B	L	X			
880624190001000	1	2-3	50	90°	black	2500	10000
880624200001000	1	3-4	30	90°	black	1000	12000
880634200001000	1	3-4	50	90°	black	2500	0
880624210001000	1	4-5	50	90°	black	2500	20000
880624220001000	1	5-6	50	90°	black	2500	17500
880624230001000	1	7-8	50	90°	black	2500	0
880624240001000	1	9-10	50	90°	black	2000	0
880624250001000	1	11-12	50	90°	black	2000	0
880624260001000	1	15-16	50	90°	black	1500	0
880624270001000	1	19-20	50	90°	black	1250	0
880624280001000	1	21-22	50	90°	black	1000	0
880624290001000	1	25-26	50	90°	black	1000	0
880624300001000	1	32-33	50	90°	black	800	9600
880624310001000	1	39-40	50	90°	black	720	0
880624330001000	1	28,5-30	50	90°	black	1000	10000
881624320001000	1	49-50	50	90°	black	500	0

Please note that the product illustrations are exemplary images that could deviate from the ordered/delivered products.
All of the dimensions are in mm should nothing to the contrary be stated.

* SW = Spanner opening, n.w. = not detachable, o. K. = excl. The head, o. B. = excl. The collar, m. R. = with the radius, MOQ = Minimum Order Quantity.

! We exclusively sell to the trade and industry. Please note our minimum order quantities and the minimum order value per delivery.
We would be pleased to send you an offer that is tailored to your needs should you require special colours, deviating dimensions, bioplastics, or larger order quantities.

Edge protective caps with one open side

SEO



Application protective elements
Material polyethylene

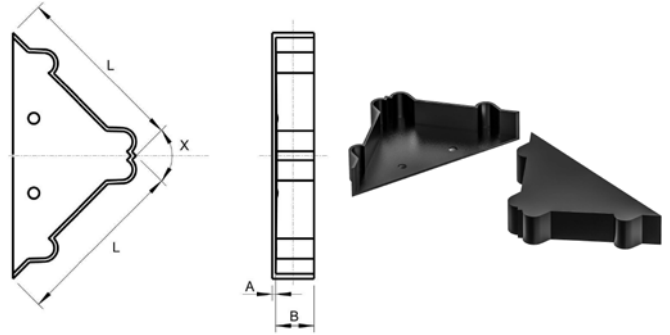

Order No.	Wall thickness	Plate thickness	Edge length	Angle	Color	packing unit	MOQ
	A	B	L	X			
880626810001000	1,0	25	50	90°	black	1500	0

Please note that the product illustrations are exemplary images that could deviate from the ordered/delivered products.

All of the dimensions are in mm should nothing to the contrary be stated.

* SW = Spanner opening, n.w. = not detachable, o. K. = excl. The head, o. B. = excl. The collar, m. R. = with the radius, MOQ = Minimum Order Quantity.

We exclusively sell to the trade and industry. Please note our minimum order quantities and the minimum order value per delivery. We would be pleased to send you an offer that is tailored to your needs should you require special colours, deviating dimensions, bioplastics, or larger order quantities.

Edge protective caps

SES



Application protective elements
Material PE

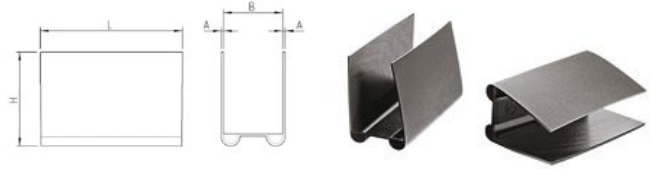

Order No.	Wall thickness A	Plate thickness B	Lenght L	Height H	Color	packing unit	MOQ
881624500001000	1	25	60,0	40,0	black	1000	0

Please note that the product illustrations are exemplary images that could deviate from the ordered/delivered products.

All of the dimensions are in mm should nothing to the contrary be stated.

* SW = Spanner opening, n.w. = not detachable, o. K. = excl. The head, o. B. = excl. The collar, m. R. = with the radius, MOQ = Minimum Order Quantity.

We exclusively sell to the trade and industry. Please note our minimum order quantities and the minimum order value per delivery. We would be pleased to send you an offer that is tailored to your needs should you require special colours, deviating dimensions, bioplastics, or larger order quantities.

Flat plugs for internal threads and drill holes

FST

Application for internal screw thread and drill holes
Material polyethylene
Standard-Colour uncoloured

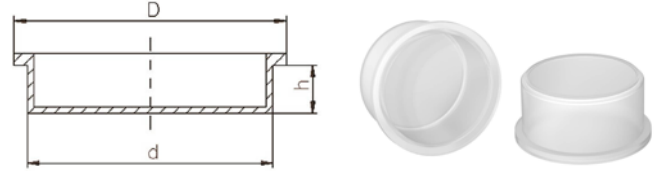

Order No.	Metric thread	DIN 13 thread	Shaft \varnothing d	Flange \varnothing D	Shaft length h	Color	packing unit	MOQ
C100420004000	M 5	-	4,2	9,0	4,5	nature	10000	0
C400910004000	-	M 10 x 1/M 10 x 1,25	9,1	12,9	6,5	nature	10000	0
C401210004000	M 14	-	12,1	15,9	7,0	nature	10000	0
C401600004000	M 18	M 17 x 1/M 18 x 2	16,0	19,6	7,7	nature	10000	0
C401960004000	-	M 20 x 0,75	19,6	23,3	8,3	nature	10000	0
C501960004000	-	M 20	22,3	25,0	11,7	nature	5000	0
C402510004000	-	M 27 x 2	25,1	28,8	8,5	nature	5000	0
C403180004000	M 36	M 33 x 1,5/ M33 x 2	31,8	35,8	8,5	nature	4000	0
C404050004000	M 45	M 42 x 1,5/M 42 x 2	40,5	47,0	9,0	nature	2000	0
C404600004000	-	M 48 x 2	46,0	51,0	9,0	nature	2000	0
C405800004000	M 64	M 60 x 2/M 62 x 4	58,0	66,0	8,0	nature	1000	0
C407250004000	-	M 75 x 3/M76 x 4	72,1	83,0	13,0	nature	500	0
C411100004000	-	-	111,5	127,5	19,0	nature	150	0

Please note that the product illustrations are exemplary images that could deviate from the ordered/delivered products.
All of the dimensions are in mm should nothing to the contrary be stated.

* SW = Spanner opening, n.w. = not detachable, o. K. = excl. The head, o. B. = excl. The collar, m. R. = with the radius, MOQ = Minimum Order Quantity.

We exclusively sell to the trade and industry. Please note our minimum order quantities and the minimum order value per delivery.
We would be pleased to send you an offer that is tailored to your needs should you require special colours, deviating dimensions, bioplastics, or larger order quantities.

Hat plugs for internal threads and drill holes

HUS

Application for internal screw thread and drill holes
 Material polyethylene
 Standard-Colour uncoloured

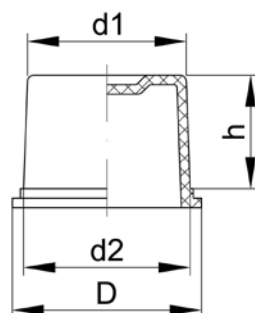

Order No.	Metric	Thread DIN 13	Shaft Ø		Head Ø	Shaft length	Color	packing unit	MOQ
			d1	d2	D	h			
CH0010004000	M 7	M 6 x 0,5	4,4	6,1	10,0	10,0	nature	10000	0
CH0020004000	M 9	-	6,0	7,7	11,0	10,0	nature	10000	0
CH0030004000	-	M 10 x 0,75	7,6	9,3	13,0	10,1	nature	10000	0
CH0040004000	-	M 11 x 1	8,4	10,1	14,0	10,0	nature	10000	0
CH0050004000	-	M 12 x 1,25	9,2	10,9	14,0	10,0	nature	10000	0
CH0060004000	-	-	9,9	11,6	15,0	10,0	nature	10000	0
CH0070004000	M 14	-	10,6	12,3	16,0	10,0	nature	10000	0
CH0080004000	-	M 14 x 1	11,2	13,0	17,0	10,0	nature	10000	0
CH0090004000	-	M 15 x 1	12,0	14,1	18,0	12,0	nature	10000	0
CH0100004000	-	M 16 x 1,5	12,5	14,6	18,0	12,0	nature	10000	0
CH0110004000	-	-	13,4	15,5	19,0	12,0	nature	10000	0
CH0120004000	-	M 17 x 2/M 18 x 2	14,0	16,1	19,0	12,0	nature	10000	0
CH0130004000	-	M 18 x 1	14,7	17,0	21,0	13,3	nature	10000	0
CH0140004000	M 20	M 20 x 1,5	16,3	18,6	22,0	13,0	nature	8000	0
CH0160004000	-	M 22 x 2	17,5	20,0	24,0	15,5	nature	5000	0
CH0180004000	-	-	19,0	21,5	25,0	15,0	nature	10000	0
CH0190004000	-	M 24 x 0,75 / M 25 x 2	20,5	23,3	27,0	16,0	nature	4000	0
CH0200004000	-	M 25 x 1,5	20,7	23,5	28,0	16,0	nature	4000	0
CH0210004000	-	-	22,0	24,8	29,0	16,0	nature	3000	0
CH0220004000	M 30	M 28 x 1,5	23,1	26,4	30,0	18,0	nature	3000	0
CH0240004000	M 33	M 30 x 1	26,4	29,2	33,0	19,0	nature	2500	0
CH0250004000	-	M 33 x 2	27,0	31,2	35,0	19,0	nature	2000	0
CH0260004000	-	M 34 x 1,5	29,8	32,6	37,0	16,0	nature	2000	0
CH0270004000	-	-	31,3	35,0	38,0	21,0	nature	1500	0
CH0280004000	-	M 39 x 2/M 40 x 3	33,3	37,1	41,0	22,0	nature	1200	0
CH0290004000	M 45	M 42 x 1,5	36,7	40,5	45,0	22,0	nature	1000	0
CH0300004000	-	-	39,0	42,5	48,0	23,0	nature	1000	0
CH0310004000	M 48	M 45 x 2	39,6	42,9	48,0	19,0	nature	1000	0
CH0320004000	-	-	41,4	44,7	49,0	19,0	nature	1000	0
CH0330004000	-	M 50 x 3	44,3	46,9	51,0	19,0	nature	1000	0

Please note that the product illustrations are exemplary images that could deviate from the ordered/delivered products.

All of the dimensions are in mm should nothing to the contrary be stated.

* SW = Spanner opening, n.w. = not detachable, o. K. = excl. The head, o. B. = excl. The collar, m. R. = with the radius, MOQ = Minimum Order Quantity.

! We exclusively sell to the trade and industry. Please note our minimum order quantities and the minimum order value per delivery. We would be pleased to send you an offer that is tailored to your needs should you require special colours, deviating dimensions, bioplastics, or larger order quantities.

Protective plugs for internal threads and drill holes

ST

Application for internal screw thread and drill holes
 Material polyethylene
 Standard-Colour uncoloured

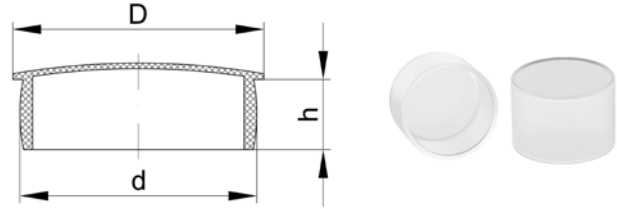

Order No.	Metric thread	DIN 13 thread	Withworth DIN 259	Shaft Ø	Head Ø	Shaft length	Color	packing unit	MOQ
				d	D	h			
C100210004000	M 2,5	M 2,2 x 0,25	-	2,0	3,5	7,0	nature	10000	0
C100320004000	M 3,5	M 3,5 x 0,35	-	3,0	12,8	5,0	nature	10000	0
C100440004000	M 5	-	-	4,4	9,0	5,5	nature	10000	0
C100470004000	-	M 5 x 0,5	-	4,6	7,0	5,0	nature	10000	0
C100520004000	M 6	M 6 x 0,75	-	5,2	11,0	6,0	nature	10000	0
C100540004000	M 6	M 6 x 0,75	-	5,4	12,0	7,5	nature	10000	10000
C100600004000	M 7	-	-	6,0	11,0	7,0	nature	10000	0
C100660004000	-	-	-	6,6	7,5	5,0	nature	10000	0
C100700004000	M 8	M 8 x 1	-	7,0	11,0	6,5	nature	10000	0
C100730004000	M 8	M 8 x 0,75 / M 8 x 1	-	7,3	11,0	6,0	nature	10000	0
C100750004000	-	M 8 x 0,75	-	7,5	11,0	4,5	nature	10000	0
C100800004000	M 9	M 9 x 1	-	8,0	12,0	7,5	nature	10000	0
C100850004000	M 10	-	-	8,5	12,0	8,0	nature	10000	0
C100880004000	M 10	M 10 x 1,25	R 1/8	8,8	11,5	8,0	nature	10000	0
C100930004000	-	M 10 x 0,75/M 10 x 1	R 1/8	9,3	12,0	9,0	nature	10000	0
C101000004000	M 11	M 11 x 1	-	10,0	15,0	9,0	nature	10000	0
C1010010004000	M 11	M 11 x 1	-	10,0	12,0	4,0	nature	10000	0
C101070004000	M 12	M 12 x 1,25 / M12 x 1,5	-	10,7	15,0	9,0	nature	10000	0
C101190004000	M 14	-	R 1/4	11,9	14,9	8,0	nature	10000	0
C1011910004000	M 14	-	R 1/4	12,0	23,0	8,0	nature	10000	0
C101250004000	M 14	M 14 x 1,5	-	12,6	17,5	9,0	nature	10000	0
C101320004000	M 14	M 14 x 1/M 14 x 1,25	-	13,2	17,5	8,0	nature	10000	0
C101360004000	-	M 14 x 0,5/M15 x 1,5	-	13,8	19,5	8,5	nature	10000	0
C101430004000	M 16	M 16 x 1,5	-	14,8	18,5	9,0	nature	10000	0
C101540004000	M 18	M 16 x 0,75/M 16 x 1	R 3/8	15,4	19,5	8,5	nature	10000	0
C101570004000	M 18	M 16 x 0,75	R 3/8	16,0	19,0	8,5	nature	10000	0
C101680004000	-	M 18 x 1,5	-	16,8	20,0	9,0	nature	10000	0

Please note that the product illustrations are exemplary images that could deviate from the ordered/delivered products.
 All of the dimensions are in mm should nothing to the contrary be stated.

* SW = Spanner opening, n.w. = not detachable, o. K. = excl. The head, o. B. = excl. The collar, m. R. = with the radius, MOQ = Minimum Order Quantity.

! We exclusively sell to the trade and industry. Please note our minimum order quantities and the minimum order value per delivery.
 We would be pleased to send you an offer that is tailored to your needs should you require special colours, deviating dimensions, bioplastics, or larger order quantities.

Protective plugs for internal threads and drill holes

ST

Application for internal screw thread and drill holes
 Material polyethylene
 Standard-Colour uncoloured

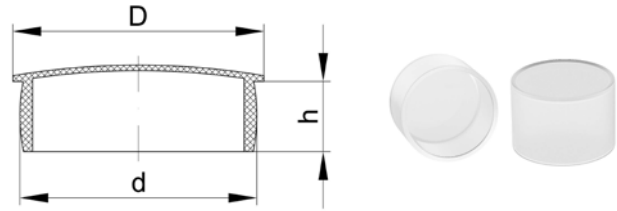

Order No.	Metric thread	DIN 13 thread	Withworth DIN 259	Shaft Ø	Head Ø	Shaft length	Color	packing unit	MOQ
				d	D	h			
C101720004000	-	M 18 x 0,75/M 16 x 1	-	17,2	23,0	9,5	nature	10000	0
C101830004000	-	M 20 x 2	-	18,9	21,5	9,2	nature	10000	0
C1019610004000	-	M 20 x 0,75	R 1/2	19,6	29,0	9,3	nature	5000	0
C102000004000	-	M 22 x 2	-	20,5	25,5	9,0	nature	5000	0
C102100004000	M 24	M 22 x 1/ 22 x 1,5	R 5/8	21,1	26,0	13,0	nature	5000	0
C102230004000	-	M 24 x 2	-	22,7	29,0	9,0	nature	5000	0
C102300004000	-	M 24 x 1	-	23,0	27,4	19,6	nature	4000	0
C102400004000	M 27	M 25 x 1	R 3/4	24,0	27,0	12,5	nature	4000	0
C102450004000	M 27	M 26 x 1/M 26 x 1,5	R 3/4	25,0	32,0	13,2	nature	1500	0
C1024510004000	M 27	M 25 x 1/M 26 x 1,5	R 3/4	25,0	36,0	13,0	nature	3000	0
C102600004000	M 28 x 2	-	-	26,0	31,5	12,0	nature	3000	0
C102720004000	M 30	M 28 x 1/M 30 x 3	-	27,1	29,6	15,0	nature	3000	0
C102860004000	-	M 30 x 1,5/M 30 x 2	R 7/8	29,0	34,5	15,0	nature	3000	0
C103120004000	M 33	M 32 x 1,5/M 33 x 2	R 1	31,2	38,0	13,0	nature	2000	0
C1031210004000	M 33	M 32 x 1,5/M 33 x 2	R 1	31,2	45,0	13,0	nature	2000	0
C103350004000	-	M 35 x 1,5	-	33,5	41,0	12,1	nature	2000	0
C103400004000	-	M 36 x 2	-	34,0	40,0	20,0	nature	1500	0
C103560004000	M 39	-	R 1 1/8	35,5	47,0	14,5	nature	1500	0
C103650004000	-	M 38 x 1,5/M 39 x 3	R 1 1/8	36,5	47,0	18,0	nature	1250	0
C103950004000	-	M 42 x 3	R 1 1/4	39,7	46,0	16,0	nature	1500	0
C1039510004000	-	M 42 x 3	R 1 1/4	39,7	51,0	15,0	nature	1200	0
C104200004000	-	M 45 x 3	-	42,0	44,5	12,8	nature	1500	0
C104330004000	M 48	M 45 x 2	-	43,3	50,5	14,5	nature	1000	0
C104550004000	-	M 48 x 3	-	45,5	51,0	16,0	nature	1000	0
C104580004000	-	-	R 1 1/2	46,0	51,5	16,5	nature	1000	0

Please note that the product illustrations are exemplary images that could deviate from the ordered/delivered products.
 All of the dimensions are in mm should nothing to the contrary be stated.

* SW = Spanner opening, n.w. = not detachable, o. K. = excl. The head, o. B. = excl. The collar, m. R. = with the radius, MOQ = Minimum Order Quantity.

! We exclusively sell to the trade and industry. Please note our minimum order quantities and the minimum order value per delivery.
 We would be pleased to send you an offer that is tailored to your needs should you require special colours, deviating dimensions, bioplastics, or larger order quantities.

Protective plugs for internal threads and drill holes

ST

Application for internal screw thread and drill holes
Material polyethylene
Standard-Colour uncoloured

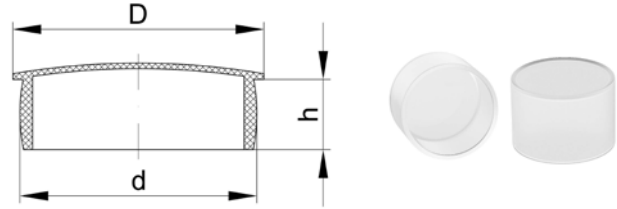

Order No.	Metric thread	DIN 13 thread	Withworth DIN 259	Shaft Ø Head Ø Shaft length			Color	packing unit	MOQ
				d	D	h			
C1045810004000	-	-	R 1 1/2	46,2	58,0	16,5	nature	1000	0
C105050004000	M 56	M 52 x 1,5/M 52 x 2	R 1 3/4	51,3	57,0	15,5	nature	750	0
C105200004000	-	M 55 x 3/M 55 x 4/ M 56 x 4	R 1 3/4	52,3	60,0	16,0	nature	1000	0
C105530004000	M 60	M 58 x 3	-	55,3	59,5	19,5	nature	750	0
C105550004000	M 60	M 58 x 3	-	55,5	58,6	15,6	nature	1000	0
C105800004000	-	M 60 x 2/M 60 x 3/M 62 x 4	R 2	57,2	62,3	19,8	nature	500	0
C106150004000	M 68	M 64 x 3/M 65 x 4	-	61,5	74,7	20,0	nature	400	0
C107000004000	-	M 72 x 2/M 72 x 3/M 76 x 6	-	70,0	80,0	18,0	nature	350	0
C108500004000	-	-	-	85,0	95,0	18,0	nature	300	0
C111000004000	-	-	R 4	110,0	130,0	17,5	nature	150	0

Please note that the product illustrations are exemplary images that could deviate from the ordered/delivered products.

All of the dimensions are in mm should nothing to the contrary be stated.

* SW = Spanner opening, n.w. = not detachable, o. K. = excl. The head, o. B. = excl. The collar, m. R. = with the radius, MOQ = Minimum Order Quantity.

We exclusively sell to the trade and industry. Please note our minimum order quantities and the minimum order value per delivery. We would be pleased to send you an offer that is tailored to your needs should you require special colours, deviating dimensions, bioplastics, or larger order quantities.

Protective caps for external threads and tubes

SKS

Application for external screw thread and tubes
 Material polyethylene
 Standard-Colour uncoloured

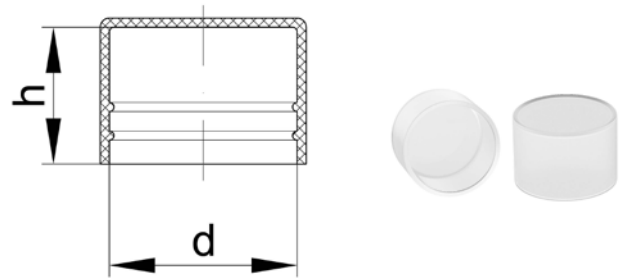

Order No.	Metric thread	Withwort tube thread DIN 259	Steel tubes DIN 2448/2458	Inside Ø		Color	packing unit	MOQ
				d	h			
C500600004000	M 6	-	-	5,7	12,0	nature	10000	0
C500800004000	M 8	-	5/16	7,8	14,3	nature	10000	0
C501000004000	M 10	R 1/8	13/32	9,8	11,0	nature	10000	0
C501020004000	-	-	-	10,2	8,0	nature	10000	0
C501050004000	-	-	-	10,5	8,0	nature	10000	0
C501200004000	M 12	-	15/32	11,5	12,0	nature	10000	0
C501300004000	-	R 1/4	-	12,7	13,5	nature	10000	0
C5013010004000	-	R 1/4	-	12,7	18,0	nature	10000	0
C501350004000	M 14	-	17/32	13,5	13,5	nature	10000	10000
C501600004000	M 16	-	5/8	15,7	15,0	nature	10000	0
C5016010004000	M 16	-	5/8	15,7	22,8	nature	5000	0
C501700004000	-	3/8	11/16	15,9	14,0	nature	8000	0
C501800004000	M18	-	23/32	17,7	15,0	nature	8000	0
C502000004000	M 20	-	25/32	19,7	14,0	nature	5000	0
C502070004000	-	R 1/2	27/32	20,6	15,0	nature	5000	0
C502130004000	M 22	-	7/8	21,3	15,5	nature	5000	0
C502400004000	M 24	-	15/16	23,5	18,5	nature	4000	0
C502600004000	M 26	-	-	25,4	17,5	nature	3000	0
C502730004000	-	R 3/4	11/16	26,2	18,5	nature	3000	0
C503000004000	M 30	-	-	29,3	18,0	nature	2000	0
C503430004000	-	R 1	1 11/32	33,4	22,5	nature	1500	0
C5034310004000	-	R 1	1 11/32	33,4	45,0	nature	800	0
C503480004000	-	-	-	34,8	25,0	nature	1500	0
C503600004000	-	-	-	35,7	14,0	nature	1500	0
C503800004000	-	-	1 1/2	37,5	20,0	nature	1500	0
C504210004000	-	R 1 1/4	1 11/16	41,9	28,0	nature	800	0
C504840004000	-	R 1 1/2	1 29/32	47,8	29,5	nature	500	0
C505200004000	-	-	-	51,6	16,0	nature	500	0
C505300004000	-	R 1 3/4	-	52,5	30,0	nature	500	0
C505730004000	-	-	2 1/4	56,7	19,0	nature	500	0
C506060004000	-	R 2	2 3/8	59,7	30,0	nature	450	0

Please note that the product illustrations are exemplary images that could deviate from the ordered/delivered products.

All of the dimensions are in mm should nothing to the contrary be stated.

* SW = Spanner opening, n.w. = not detachable, o. K. = excl. The head, o. B. = excl. The collar, m. R. = with the radius, MOQ = Minimum Order Quantity.

! We exclusively sell to the trade and industry. Please note our minimum order quantities and the minimum order value per delivery. We would be pleased to send you an offer that is tailored to your needs should you require special colours, deviating dimensions, bioplastics, or larger order quantities.

Protective caps for external threads and tubes

SKS

Application for external screw thread and tubes
Material polyethylene
Standard-Colour uncoloured

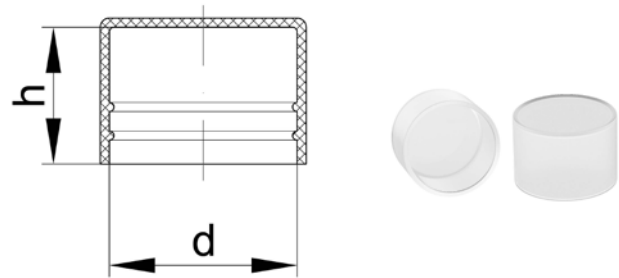

Order No.	Metric thread	Withwort tube thread DIN 259	Steel tubes DIN 2448/2458	Inside Ø		Height	Color	packing unit	MOQ
				d	h				
C5060620004000	-	R2	2 3/8	59,7	-	nature	400	0	
C507000004000	-	-	2 1/4	69,8	25,0	nature	400	0	
C507160004000	-	R 2 1/2	-	75,5	35,0	nature	200	0	
C507650004000	-	-	3	75,8	18,0	nature	400	0	
C508000004000	-	-	-	79,8	25,0	nature	300	0	
C508920004000	-	R 3	-	88,4	36,0	nature	150	0	
C510180004000	-	-	4	108,8	-	nature	150	0	

Please note that the product illustrations are exemplary images that could deviate from the ordered/delivered products.

All of the dimensions are in mm should nothing to the contrary be stated.

* SW = Spanner opening, n.w. = not detachable, o. K. = excl. The head, o. B. = excl. The collar, m. R. = with the radius, MOQ = Minimum Order Quantity.

We exclusively sell to the trade and industry. Please note our minimum order quantities and the minimum order value per delivery. We would be pleased to send you an offer that is tailored to your needs should you require special colours, deviating dimensions, bioplastics, or larger order quantities.